

REFORM 52 IN-OUT RECESSED

Installation Manual

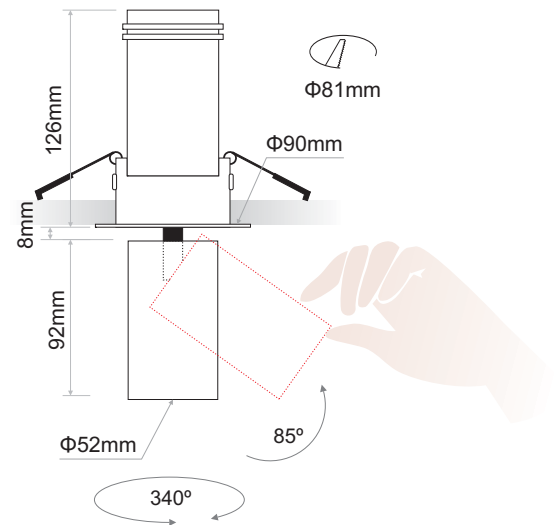

To pull OUT the spot

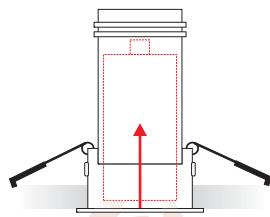
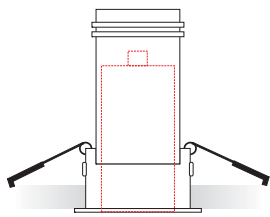

1. Push in the spot.

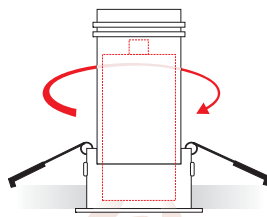

2. Turn the spot left to unlock.

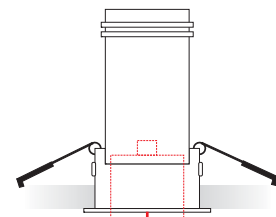

3. Once the spot is unlocked pull it downwards to the desired level.

To pull IN the spot

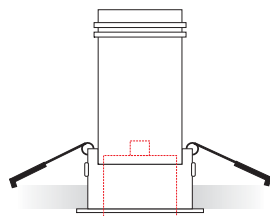
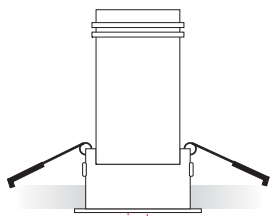

1. Push the spot inside.

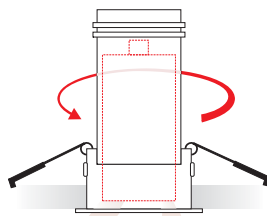

2. Once all the spot is inside then turn the spot right.

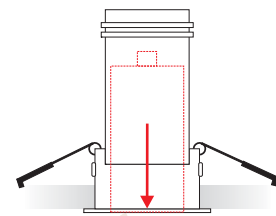

3. Release the spot to lock.

REFORM 52 IN-OUT RECESSED

Installation Manual



1



Attention

Before any maintenance switch off the main power.

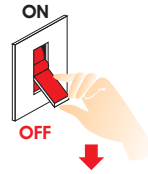

2

2.1

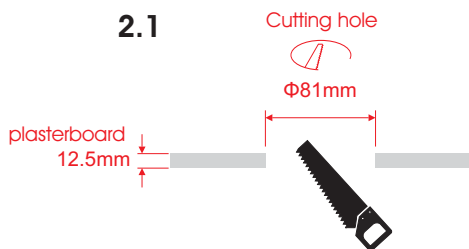

2.2

Connect the LED Driver at 230VAC.

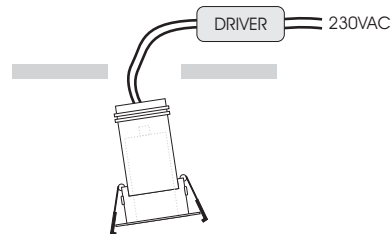

3

3.1

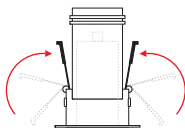

3.2

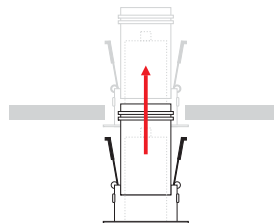

3.3

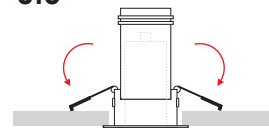

4

